

# Iwaki

## Electromagnetic Metering Pump

### EJ-B(R) (North America)

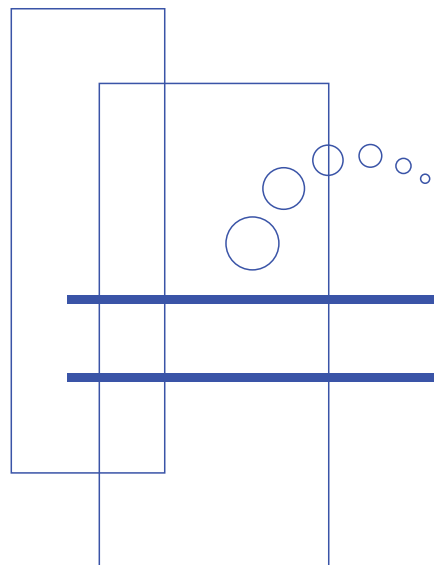
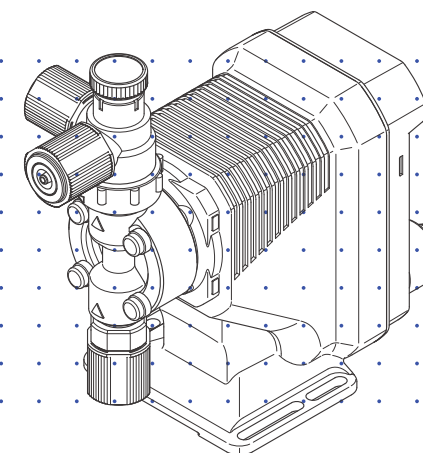

Australia	IWAKI Pumps Australia Pty. Ltd.	TEL: (61)2 9899 2411	FAX: 2 9899 2421	Italy	IWAKI Europe GmbH, Italy Branch	TEL: (39)0444 371115	FAX: 0444 336350
Austria	IWAKI EUROPE GmbH	TEL: (49)2154 92540	FAX: 2154 9254 48	Korea	IWAKI Korea Co.,Ltd.	TEL: (82)2 2630 4800	FAX: 2 2630 4801
Belgium	IWAKI Belgium n.v.	TEL: (32)1367 0200	FAX: 1367 2030	Malaysia	IWAKIm Sdn. Bhd.	TEL: (60)3 7803 8807	FAX: 3 7803 4800
China	IWAKI Pumps (Shanghai) Co., Ltd.	TEL: (86)21 6272 7502	FAX: 21 6272 6929	Norway	IWAKI Norge AS	TEL: (47)23 38 49 00	FAX: 23 38 49 01
China	IWAKI Pumps (Guangdong) Co., Ltd.	TEL: (86)750 3866228	FAX: 750 3866278	Singapore	IWAKI Singapore Pte. Ltd.	TEL: (65)6316 2028	FAX: 6316 3221
China	GFTZ IWAKI Engineering & Trading (Guangzhou)	TEL: (86)20 8435 0603	FAX: 20 8435 9181	Spain	IWAKI Europe GmbH, Spain Branch	TEL: (34)93 37 70 198	FAX: 93 47 40 991
China	GFTZ IWAKI Engineering & Trading (Beijing)	TEL: (86)10 6442 7713	FAX: 10 6442 7712	Sweden	IWAKI Sverige AB	TEL: (46)8 511 72900	FAX: 8 511 72922
Denmark	IWAKI Nordic A/S	TEL: (45)48 24 2345	FAX: 48 24 2346	Switzerland	IP Service SA	TEL: (41)26 674 9300	FAX: 26 674 9302
Finland	IWAKI Suomi Oy	TEL: (358)9 2745810	FAX: 9 2742715	Taiwan	IWAKI Pumps Taiwan Co., Ltd.	TEL: (886)2 8227 6900	FAX: 2 8227 6818
France	IWAKI France S.A.	TEL: (33)1 69 63 33 70	FAX: 1 64 49 92 73	Taiwan	IWAKI Pumps Taiwan (Hsin-chu) Co., Ltd.	TEL: (886)3 573 5797	FAX: (886)3 573 5798
Germany	IWAKI EUROPE GmbH	TEL: (49)2154 92540	FAX: 2154 9254 48	Thailand	IWAKI (Thailand) Co.,Ltd.	TEL: (66)2 322 2471	FAX: 2 322 2477
Holland	IWAKI Europe GmbH, Netherlands Branch	TEL: (31)74 2420011	FAX: 2154 9254 48	U.K.	IWAKI Pumps (UK) LTD.	TEL: (44)1743 231363	FAX: 1743 366507
Hong Kong	IWAKI Pumps Co., Ltd.	TEL: (852)2 607 1168	FAX: 2 607 1000	U.S.A.	IWAKI AMERICA Inc	TEL: (1)508 429 1440	FAX: 508 429 1386
Indonesia	IWAKI Singapore (Indonesia Branch)	TEL: (62)21 690 6606	FAX: 21 690 6612	Vietnam	IWAKI Pumps Vietnam Co.,Ltd.	TEL: (84)613 933456	FAX: 613 933399

## Instruction manual

Thank you for choosing our product.



Please read through this instruction manual before use.



This instruction manual describes important precautions and instructions for the product. Always keep it on hand for quick reference.

## Order confirmation

Open the package and check that the product conforms to your order. If any problem or inconsistency is found, immediately contact your distributor.

### **a. Check if the delivery is correct.**

Check the nameplate to see if the information such as model codes, discharge capacity and discharge pressure are as ordered.

<b>Iwaki Metering Pump</b>		Thermally Protected	1P427119
MODEL		Acceptable for indoor use only	
PRESSURE	PSI	Enclosure type 2	
CAPACITY	GPH	Utilisation intérieure	
STROKE RATE	spm	uniquement	
VOLTAGE	V	Boîtier de type 2	
CURRENT	A	Nonsubmersible Pump	
FREQUENCY	Hz	Conforms to ANSI/UL Std.778	
MAX. LIQUID TEMP.	°F	Certified to	
MFG.No.		CAN/CSA Std.C22.2 No.108	
Year :		 PM16-2	
		 <b>IWAKI CO.,LTD.</b> MADE IN JAPAN	



### **b. Check if the delivery is damaged or deformed.**

Check for transit damage and loose bolts.

# Contents

Order confirmation .....	2
--------------------------	---

## **Safety instructions ..... 6**

Warning.....	7
--------------	---

Caution.....	9
--------------	---

Precautions for use .....	13
---------------------------	----

## **Overview..... 17**

Introduction.....	17
-------------------	----

Pump structure & Operating principle .....	17
--	----

Features.....	18
---------------	----

<b>Operational functions .....</b>	<b>18</b>
------------------------------------	-----------

Manual mode .....	18
-------------------	----

EXT mode.....	19
---------------	----

STOP function .....	19
---------------------	----

<b>Part names.....</b>	<b>20</b>
------------------------	-----------

Pump.....	20
-----------	----

Operational panel .....	21
-------------------------	----

Basic displays & Pump states .....	22
------------------------------------	----

<b>Identification codes.....</b>	<b>23</b>
----------------------------------	-----------

## **Installation ..... 24**

<b>Pump mounting.....</b>	<b>24</b>
---------------------------	-----------

<b>Pipework.....</b>	<b>25</b>
----------------------	-----------

Tube connection .....	25
-----------------------	----

Check valve mounting .....	27
----------------------------	----

<b>Wiring.....</b>	<b>29</b>
--------------------	-----------

Power voltage/Earthing .....	29
------------------------------	----

Signal wire connection.....	31
-----------------------------	----

Input signal.....	32
-------------------	----

**Operation..... 33**

**Before operation..... 33**

- Points to be checked ..... 33
- Retightening of pump head fixing bolts ..... 33
  - Use of hexagon wrench instead of a torque wrench ..... 34
- Degassing..... 34
- Flow rate adjustment .....37
- Before a long period of stoppage (one month or more)..... 39

**Operation programming ..... 40**

- Programming flow..... 40
- Manual operation .....41
- EXT operation..... 43
- STOP function ..... 44
- Keypad lock ..... 45
  - Keypad lock activation..... 45
  - Keypad lock release ..... 45

**Maintenance..... 46**

**Troubleshooting.....47**

**Inspection..... 48**

- Daily inspection ..... 48
- Periodic inspection ..... 48

**Wear part replacement..... 49**

- Wear part list..... 49
- Before replacement ..... 50
- Valve set replacement .....51
  - Discharge valve set dismantlement/assembly .....51
  - Suction valve set dismantlement/assembly ..... 53
- Diaphragm replacement ..... 54

<b>Exploded view</b> .....	<b>57</b>
Pump head & Drive unit.....	57
Pump head .....	58
<b>Specifications/Outer dimensions</b> .....	<b>59</b>
Specifications .....	59
Pump unit .....	59
Control unit.....	60
Power cable.....	60
Pump colour .....	60
Outer dimensions.....	61
EJ-B09/-B11/-B16/-B21 VC/VE/VH.....	61
EJ-B11/-B16/-B21 TC .....	61

# Safety instructions

**Read through this section before use. This section describes important information for you to prevent personal injury or property damage.**

## ■ Symbols

In this instruction manual, the degree of risk caused by incorrect use is noted with the following symbols. Please pay attention to the information associated with the symbols.



### **WARNING**

Indicates mishandling could lead to a fatal or serious accident.



### **CAUTION**

Indicates mishandling could lead to personal injury or property damage.

A symbol accompanies each precaution, suggesting the use of "Caution", "Prohibited actions" or specific "Requirements".

#### Caution marks



Caution



Electrical shock

#### Prohibited mark



Prohibited



Do not rework or alter

#### Requirement mark



Requirement



Wear protection



Grounding



## **Export Restrictions**

Technical information contained in this instruction manual might be treated as controlled technology in your countries, due to agreements in international regime for export control.

Please be reminded that export license/permission could be required when this manual is provided, due to export control regulations of your country.

**! WARNING****Turn off power before service**

Risk of electrical shock. Be sure to turn off power to stop the pump and related devices before service is performed.

**Couper l'alimentation électrique de la pompe avant intervention**

Intervenir sur la pompe sans avoir au préalable coupé l'alimentation électrique peut déclencher des décharges électriques. Avant d'entreprendre n'importe quel type d'intervention, veillez à mettre la pompe et tout dispositif connexe hors tension à l'aide de l'interrupteur prévu à cet effet.

**Stop operation**

If you notice any abnormal or dangerous conditions, suspend operation immediately and inspect/solve problems.



Requirement

**Arrêter le fonctionnement**

Si vous détectez une anomalie ou des signes suspects et inhabituels pendant le fonctionnement, interrompez immédiatement les opérations et inspectez, résolvez les problèmes.

**Do not use the pump in any condition other than its intended purpose**

The use of the pump in any conditions other than those clearly specified may result in failure or injury. Use this product in specified conditions only.



Prohibited

**Se conformer uniquement aux applications prévues**

La pompe doit être utilisée conformément à l'usage pour lequel elle a été prévue et dans le respect de ses caractéristiques techniques. Toute utilisation non conforme peut entraîner un incident ou endommager le dispositif.

**Do not modify the pump**

Alterations to the pump carries a high degree of risk. It is not the manufacturer's responsibility for any failure or injury resulting from alterations to the pump.



Do not rework or alter

**Ne pas modifier la pompe**

Ne jamais modifier une pompe sous peine de causer un incident grave. Iwaki ne pourra en aucun cas être tenu responsable d'un incident ou de dégâts survenus à la suite d'une modification du dispositif.

---

### **Wear protective clothing**

Always wear protective clothing such as an eye protection, chemical resistant gloves, a mask and a face shield during disassembly, assembly or maintenance work. The specific solution will dictate the degree of protection. Refer to MSDS precautions from the solution supplier.



### **Porter un équipement de protection**

Toujours porter un équipement de protection (lunettes, gants résistants aux produits chimiques, masque, casque) durant le démontage, l'assemblage et la maintenance.

Le travail effectué dictera le degré de protection. Référez-vous au MSDS de la solution proposée par le fournisseur.

---

### **Do not damage the power cable**

Do not pull, knot, or crush the power cable. Damage to the power cable could lead to a fire or electrical shock if cut or broken.



### **Ne pas endommager le câble électrique**

Ne pas tirer ou faire un nœud avec le câble électrique. Endommager un câble électrique peut provoquer un incendie ou une décharge électrique.

---

### **Do not operate the pump in a flammable atmosphere**

Do not place explosive or flammable material near the pump.



### **Ne pas utiliser la pompe dans une atmosphère explosive**

Pour votre sécurité, du matériel dangereux ou inflammable ne doit pas être placé près de la pompe.

---

### **Risk of electric shock**

This pump is supplied with a grounding conductor and grounding-type attachment plug. To reduce the risk of electric shock, be certain that it is connected only to a properly grounded, grounding type receptacle.



### **Risque de choc électrique**

La pompe est fournie avec un conducteur pour mise à la terre et une prise courant. Afin de réduire le risque de choc électrique, veillez à ce que la terre soit correctement raccordée.



 **CAUTION****Qualified personnel only**

The pump should be handled or operated by qualified personnel with a full understanding of the pump. Any person not familiar with the product should not take part in the operation or maintenance of the pump.

**Opérateur qualifié uniquement**

La pompe doit être manipulée ou utilisée par du personnel qualifié connaissant parfaitement la pompe. Tout autre personne étrangère ne doit pas prendre part à l'utilisation ou à la maintenance de la pompe.



Requirement

**Use specified power only**

Do not apply power other than that specified on the nameplate. Otherwise, failure or fire may result. Ensure the pump is properly grounded.

**Utilisez une tension appropriée uniquement**

Ne pas appliquer une autre tension que celle spécifiée sur la plaque signalétique sinon, il peut en résulter une panne ou un incendie. Assurez-vous également de la mise à la terre de la pompe.



Prohibited

**Do not run pump dry**

Do not run pump dry for more than 30 minutes (even when the pump runs for degassing). Otherwise, the pump head fixing screws may loosen and liquid may leak. Optimise your system. If the pump runs dry for a long period (for more than 30 minutes), the pump head and the valve cases may deform by friction heat and consequently leakage results.

**Ne faite pas fonctionner la pompe à sec**

Ne faite pas fonctionner la pompe à sec plus de 30 minutes (même lorsque la pompe fonctionne pour dégazer). Sinon, les visse de fixation de la tête peuvent se dévisser et il peut y avoir une fuite de liquide. Optimalisez l'installation de façon à ce que la pompe ne fonctionne pas à sec. Si la pompe fonctionne à sec pour une longue période (plus de 30 minutes), la tête de la pompe et le guide de clapets peuvent être déformés par friction causée par la chaleur et il en résulterait des fuites.



Caution

---

### Keep electric parts and wiring dry

Risk of fire or electric shock. Install the pump where it can be kept dry.

### Ne mouillez pas les parties électriques ou les câbles

Risque d'incendie ou de décharge électrique. Installez la pompe dans un endroit sec.



Prohibited

---

### Observe an applicable MSDS

Take account of installation environment. Chemicals should be controlled in accordance with a MSDS. Do not send potable water or circulate heated water with this pump.

### Observez un « MSDS » applicable

Tenez compte de l'environnement. Les produits chimiques doivent être surveillés en accord avec un MSDS. Ne pas utiliser cette pompe avec de l'eau potable ou de l'eau chaude.



Caution

---

### Do not install or store the pump:

- In a flammable atmosphere.
- In a dusty/humid environment.
- Where ambient temperature can exceed 0-40°C.
- In direct sunlight or wind & rain.

### N'installez ou ne stockez pas la pompe dans les endroits suivantes:

- Dans une atmosphère inflammable
- Dans un endroit poussiéreux ou humide.
- Dans une place où la température n'est pas comprise entre 0 et 40 °C.
- Directement sous le soleil, le vent ou la pluie.



Prohibited

---

### Spill precautions

Ensure protection and containment of solution in the event of plumbing or pump damage (secondary containment).

### Déversement accidentel

Prenez des mesures protectrices contre tout incident résultant d'un débit trop important de la pompe ou d'une casse de tuyauterie.



Requirement

**Do not use the pump in a wet location**

The pump is not waterproof. Use of the pump in wet or extremely humid locations could lead to electric shock or short circuit.



Prohibited

**N'utilisez pas la pompe sous l'eau**

La pompe n'est pas complètement étanche. Utiliser la pompe dans l'eau ou dans un endroit très humide peut créer une décharge électrique ou un court-circuit.

**Grounding**

Risk of electrical shock! Always properly ground the pump. Conform to local electric codes.



Grounding

**Mise à la terre**

Veillez à ne pas faire fonctionner la pompe sans avoir au préalable prévu une mise à la terre. Celle-ci permettra d'éviter d'éventuelles décharges électriques. Vérifiez que le câble de mise à la terre est bien branché.

**Install a GFCI (earth leakage breaker)**

An electrical failure of the pump may adversely affect other devices on the same line. Purchase and install a GFCI (earth leakage breaker) separately.



Electrical shock

**Détecteur de fuites à la terre**

Un problème électrique peut affecter défavorablement le dispositif. Achetez et installez un détecteur de fuites à la terre.

**Preventative maintenance**

Follow instructions in this manual for replacement of wear parts. Do not disassemble the pump beyond the extent of the instructions.



Requirement

**Remplacement des pièces usées**

Suivez les instructions de ce manuel pour remplacer les pièces usées. Ne démontez pas la pompe au-delà des instructions.

**Do not use a damaged pump**

Use of a damaged pump could lead to an electric shock or death.



Prohibited

**N'utilisez pas une pompe endommagée**

Utiliser une pompe endommagée peut provoquer une décharge électrique ou la mort.

---

## Disposal of a used pump

Dispose of any used or damaged pump in accordance with local rules and regulations. If necessary, consult a licensed industrial waste disposal company.



Requirement

## Élimination des pompes usées

Elle doit se faire en conformité avec les règles locales en vigueur (consultez une entreprise certifiée et spécialisée).

---

## Check pump head bolts

Liquid may leak if any of the pump head bolts become loose. Tighten the bolts evenly to the following torque in diagonal order before initial operation and at regular intervals.

### Tightening torque

19 lb-in



Caution

## Serrez la tête de pompe

La pompe peut fuiter si les boulons sont desserrés. Resserrez les boulons diagonalement et uniformément avant la première utilisation. Resserrez les boulons régulièrement pour éviter toute fuite.

Couple de serrage

19 lb-in

---

## Solution compatibility

This pump has been evaluated for use with water only. The suitability of this pump for use with liquids other than water, such as acid and alkaline, is the responsibility of the user. For liquids other than water, select the best-suited liquid end material combination using a chemical compatibility chart.



Caution

## Compatibilité avec la solution

Cette pompe a été évaluée pour l'utilisation avec l'eau uniquement. L'aptitude de cette pompe à être utilisée avec d'autres produits, tels que les acides et les alcalins, est de la responsabilité de l'utilisateur. Pour des liquides autres que l'eau, choisissez le matériel le plus compatible selon la résistance chimique.

## Precautions for use

- Electrical work should be performed by a qualified electrician. Otherwise, personal injury or property damage could result.

Le raccordement électrique de la pompe doit être effectué par du personnel qualifié sinon, il pourrait y avoir un dommage corporel ou incorporel.



- Do not install the pump:
  - In a flammable atmosphere.
  - In a dusty/humid place.
  - In direct sunlight or wind & rain.
  - Where ambient temperature can exceed 0-40°C.

Protect the pump with a cover when installing it out of doors.

Ne pas installer la pompe dans les endroits suivants:

- Dans une atmosphère inflammable
- Dans une atmosphère poussiéreuse ou humide.
- Sous les rayonnements du soleil, dans le vent ou sous la pluie.
- La température ambiante doit être comprise entre 0 et 40°C.

Protégez la pompe par un capot si vous l'installez dehors.

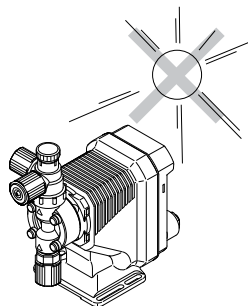

- Select a level location, free from vibration, that won't hold liquid. Anchor the pump with four M5 bolts so it doesn't vibrate. If the pump is not installed level, output may be affected.

Choisissez un endroit où il n'y a pas de vibrations et où le liquide peut s'évacuer. Fixez la pompe à l'aide de vis M5 de façon à ne pas avoir de vibrations. Si la pompe est inclinée, le débit peut être réduit.

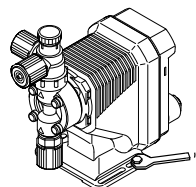

- When two or more pumps are installed together, vibration may be significant, resulting in poor performance or failure. Select a solid foundation (concrete) and fasten anchor bolts securely to prevent vibration during operation.



Si plusieurs pompes sont installées ensemble, elles interagissent et les vibrations peuvent devenir importantes, ce qui engendre des performances médiocres ou des ratures. Choisissez un endroit solide et fixez les boulons correctement pour éviter les vibrations pendant le fonctionnement.

- Allow sufficient space around the pump for easy access and maintenance.



Prévoyez de l'espace autour de la pompe pour faciliter l'accès et la maintenance.

- Install the pump as close to the supply tank as possible.



Installez la pompe le plus près possible du tank de produit.

- When handling liquids that generate gas bubbles (sodium hypochlorite or hydrazine solution), install the pump in a cool and dark place. Flooded suction installation is strongly recommended.



Installez la pompe dans une place froide à l'abri du soleil lorsqu'il s'agit du dosage de produits dégazant tels que l'hypochlorite de sodium ou l'hydrazine. Mettre la pompe en charge est vivement recommandé.

- Use care handling the pump. Do not drop. An impact may affect pump performance. Do not use a pump that has been damaged to avoid the risk of electrical damage or shock.

Veillez à ne pas laisser tomber la pompe sur le sol. Un impact important pourrait réduire les performances de la pompe. Ne pas utiliser une pompe endommagée sinon il pourrait y avoir un courant de fuite ou une décharge électrique.

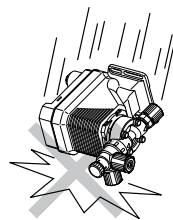

- The pump has a rating of IP65 equivalent, but is not waterproof. Do not operate the pump while wet with solution or water. Failure or injury may result. Immediately dry off the pump if it gets wet.

Le pompe est IP65 équivalent mais n'est pas complètement étanche. Ne pas laisser la pompe couverte de liquide pompé ou sous la pluie. Il pourrait y avoir des ratés ou préjudices. Si la pompe a été mouillée, sechez-la directement.



- Do not close discharge line during operation. Solution may leak or piping may break. Install a relief valve to ensure safety and prevent damaged plumbing.

Ne fermez pas la ligne de refoulement lorsque la pompe est en fonctionnement sinon il pourrait y avoir des fuites de liquide ou la tuyauterie pourrait céder. Installez une soupape de sécurité pour des raisons de sécurité et pour éviter tout dommage de la tuyauterie.



- Solution in the discharge line may be under pressure. Release the pressure from the discharge line before disconnecting plumbing or disassembly of the pump to avoid solution spray.

Le liquide au refoulement peut être sous pression. Relâchez la pression du refoulement avant de démonter la pompe ou d'enlever le tubage pour éviter tout jet de liquide.



- Wear protective clothing when handling or working with pumps. Consult solution MSDS for appropriate precautions. Do not come into contact with residual solution.

Portez un équipement de sécurité lorsque vous manipulez la pompe. Consultez le MSDS pour utilisez les précautions appropriées. Évitez tout contact avec le liquide chimique.



- Do not clean the pump or nameplate with a solvent such as benzine or thinner. This may discolour the pump or erase printing. Use a dry or damp cloth or a neutral detergent.

Ne nettoyez pas la pompe ou la plaque signalétique à l'aide d'un solvant comme le benzène ou le white spirit. Cela pourrait décolorer la pompe ou effacer l'impression. Utilisez un tissu sec ou mouillé avec de l'eau ou un détergent neutre.



- This pump has been evaluated for use with water only. Cette pompe a été testée uniquement avec de l'eau.





# Overview

**Pump characteristics, features and part names are described in this section.**

## Introduction

### **Pump structure & Operating principle**

The EJ series is a diaphragm metering pump which consists of a pump head and a drive unit with a built-in controller. A diaphragm is directly driven by electromagnetic force.

#### **Principle of operation**

The pulse signal via the PCB generates the electromagnetic force to make reciprocating motion with the assistance of the spring force. The reciprocating motion is transferred to a diaphragm through a plunger and then volumetric change occurs in the pump head. This action transfers liquid along with pump head valve action.

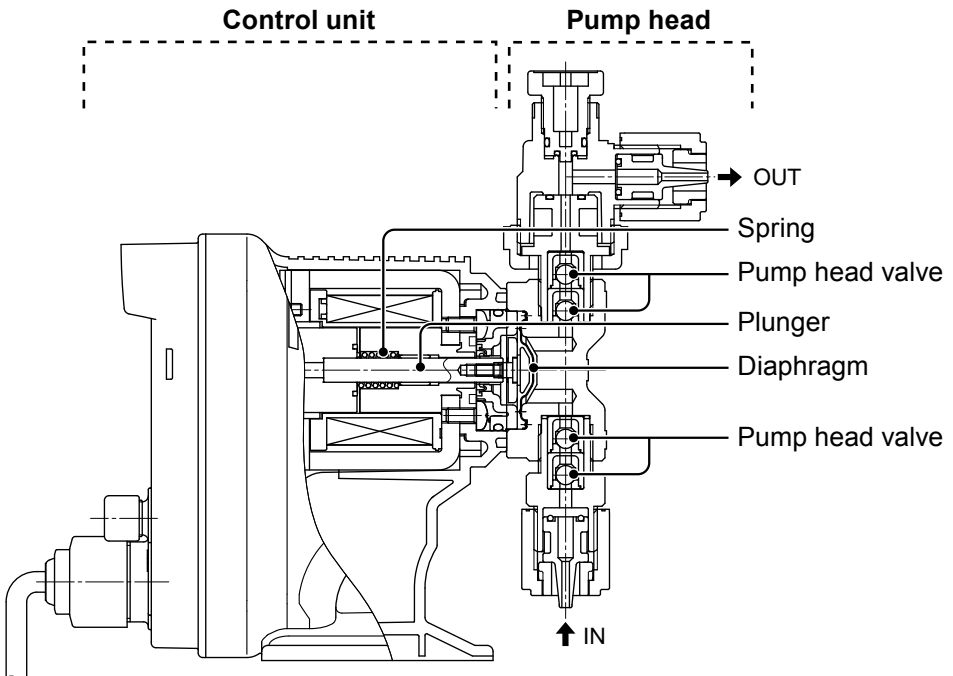

# Features

---

- **Multivoltage operation**

The EJ series is a multivoltage type (U:100-120VAC, U2:100-240VAC) and can be selected without local power limitations.

- **High turndown ratio**

Digitally-controlled spm range is 1-360spm.

- **IP rating of 65 equivalent**

This pump is not waterproof. Protect the pump with a cover when installing it out of doors.

## Operational functions

### Manual mode

---

Run/stop the pump by the start/stop key. A stroke rate (MAN speed) can be changed in the range of 1-360spm by the up key at any time during operation or stop. See page 41 for detail.

\*The pump can also be turned ON/OFF by switching the main power.

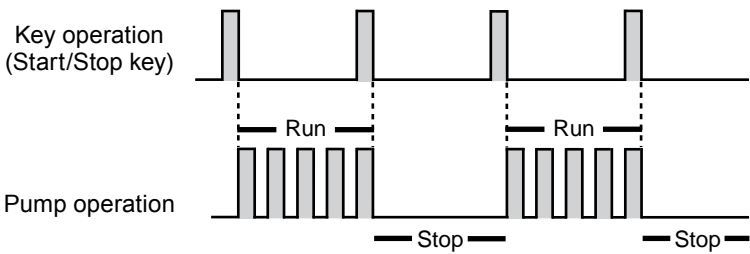

## EXT mode

The pump operation by the external signal. In this mode, the multiplier is fixed to 1 and the pump makes one shot at every input of the signal. See page 43 for detail.

Example) The pump makes one shot per signal.

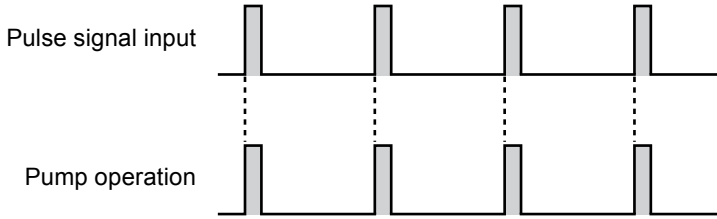

## STOP function

The start/stop of the pump can be controlled by the external STOP signal. See page 44 for detail.

\*The pump resumes operation when the STOP signal is released.

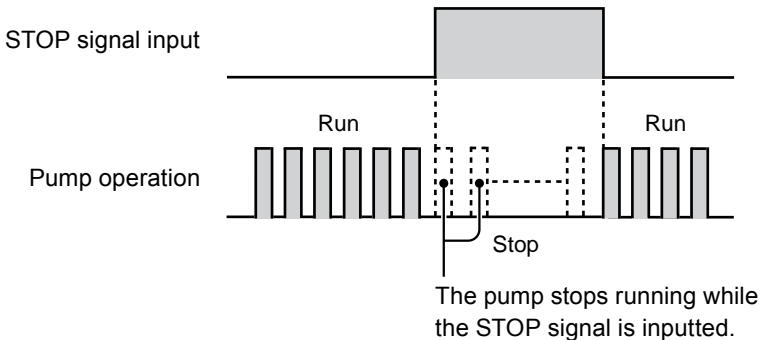

## Pump

### Air vent port

Always connect a tube. Be sure to return the tube end to a supply tank or a container.

A circumferential direction of the port can be changed up to 90 degrees counterclockwise from the original position.

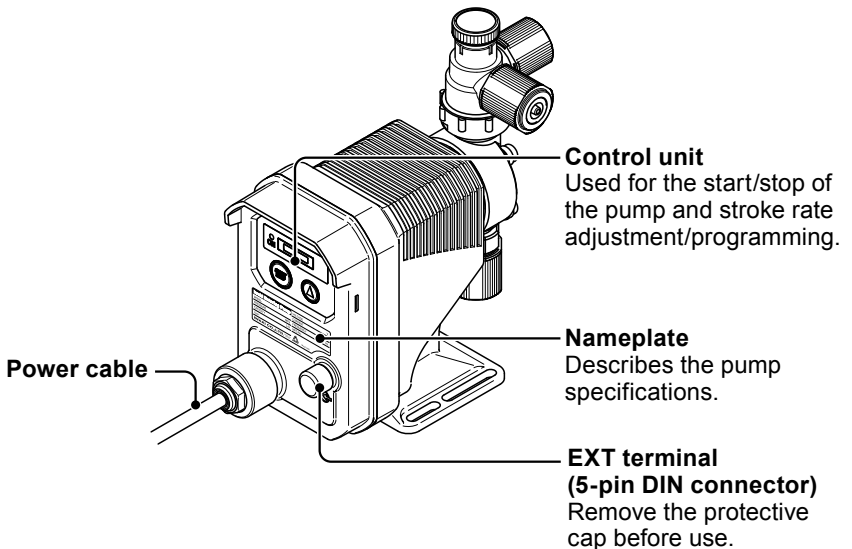
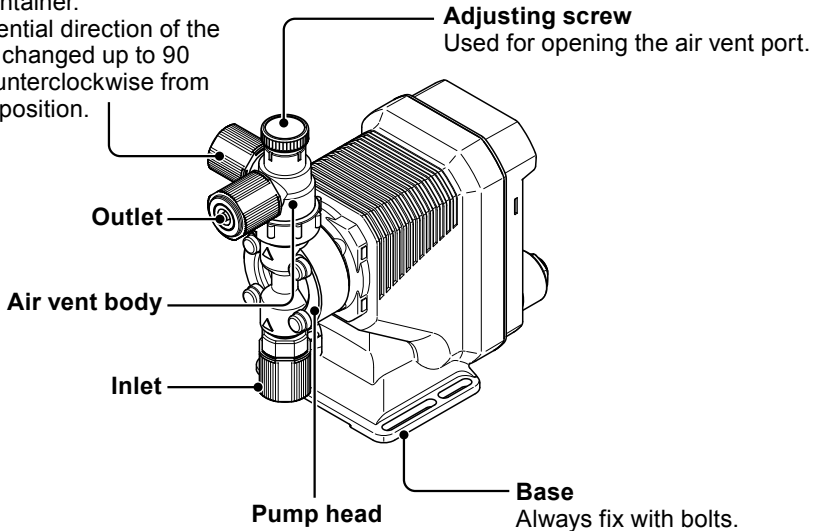

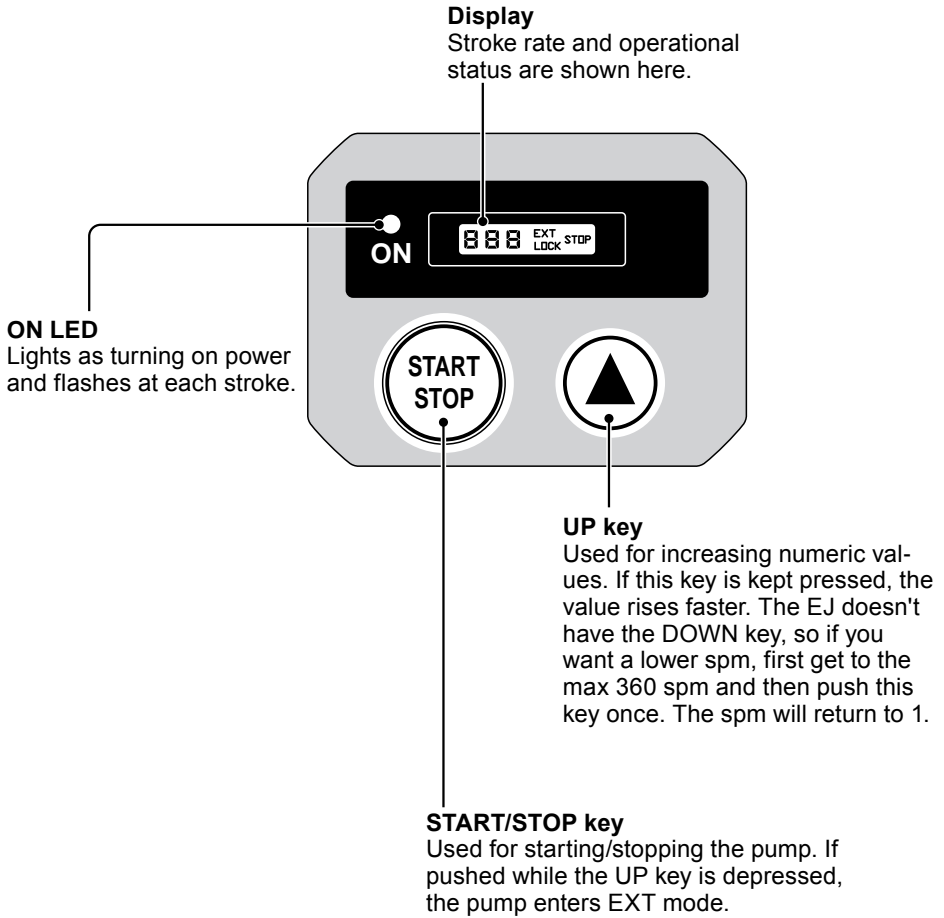

## ■ Basic displays & Pump states

Shows a pump speed in spm. The spm flashes during operation in MAN and EXT modes. The indication changes to "--" when the pump enters maintenance mode.

Represents the pump is in EXT mode.



Represents the pump is receiving the STOP signal.

Represents keypads are locked.

Display info	ON LED lights	ON LED flashes (in sync with each shot)
	A wait state in MAN mode: The display shows the MAN speed in spm.	Operation in MAN mode: A current spm flashes (not in sync with a pump shot).
	—	Operation in EXT mode: A current spm flashes (not in sync with a pump shot).
	STOP signal is entered in MAN mode. If the spm flashes, it means the pump is just suspended and will restart as the signal is turned OFF.	—
	STOP signal is entered in EXT mode. If the spm flashes, it means the pump is just suspended and will restart as the signal is turned OFF.	—
 	—	Keypads are locked and any key operation is cancelled.
 	Keypads are locked in a suspended MAN/EXT mode with the STOP signal.	—
	The pump is in maintenance mode. When extending the diaphragm, the display flashes.	—

## Identification codes

The model codes of the pump/drive units represent the following information.

**EJ - B 11 VC**  **U R**  -    
**a b c d e f g h i**

### a. Series name

EJ: Multivoltage electromagnetic metering pump

### b. Drive unit (Average power consumption)

B: 15W

### c. Diaphragm effective diameter

09: 8mm      11: 10mm      16: 15mm      21: 20mm

### d. Wet end materials

Code	Pump head	Valve	O ring	Valve seat	Gasket	Diaphragm
VC	PVC	Alumina ceramic	FKM	FKM	PTFE	PTFE + EPDM (EPDM is not a wet end.)
VH		HC276	EPDM	EPDM		
VE		Alumina ceramic				
TC	PVDF		FKM	FKM		

#### Material code

PVC : Transparent polyvinyl chloride

HC276 : HASTELLOY C276

EPDM : Ethylene-propylene rubber

PVDF : Polyvinylidene difluoride

FKM : Fluorine-contained rubber

PTFE : Polytetrafluoroethylene

### e. Tube I.D.

Material	VC	VH	VE	TC
No code	ø1/4"×ø3/8"	ø1/4"×ø3/8"	ø1/4"×ø3/8"	ø1/4"×ø3/8"
1	ø4×ø9	ø4×ø9	ø4×ø9	—
2	ø4×ø6	ø4×ø6	ø4×ø6	ø4×ø6
3	ø6×ø8	ø6×ø8	ø6×ø8	ø6×ø8
7	ø1/4"×ø3/8"	ø1/4"×ø3/8"	ø1/4"×ø3/8"	ø1/4"×ø3/8"
23	ø6×ø12	—	—	—
24	ø5×ø8	—	—	ø5×ø8

### f. Power cable

U: American 115VAC type (rated voltage 100-120VAC, with 5-15 plug)

U2: American 230VAC type (rated voltage 100-240VAC, with 6-15 plug)

### g. Control unit function

R: With external control

### h. Special version

### i. Special configuration

# Installation

***This section describes the installation of the pump, tubing and wiring. Read through this section before work.***

**!** Observe the following points when installing the pump.

- Risk of electrical shock. Be sure to turn off power to stop the pump and related devices before service is performed.
- If you notice any abnormal or dangerous conditions, suspend operation immediately and inspect/solve problems.
- Do not place explosive or flammable material near the pump.
- Do not use a damaged pump. Use of a damaged pump could lead to an electric shock or death.

## Pump mounting

*Select an installation location and mount the pump.*

### Necessary tools

- Four M5 bolts (pump mounting)
- Adjustable wrench or spanner

### 1 Select a suitable place.

Select a level location, free from vibration, that won't hold liquid. See page 13 for detail. Flooded suction is recommended when handling a gaseous liquid such as sodium hypochlorite.

### 2 Anchor the pump with the M5 bolts.

Be sure to fix the pump at four points.

#### NOTE

Select a level location. If the pump is not installed level, output may be affected.

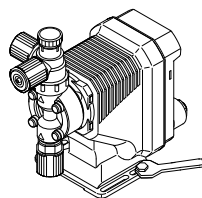



## Pipework

Connect tubes to the pump and install a check valve.

### Before operation

- Cut the tube ends flat.

Tube end (Side view)

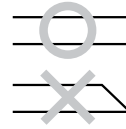

### Necessary tools

- Adjustable wrench or spanner

## Tube connection

- Pass a tube into the fitting nut and hoes stopper and then slide it down to the hose adapter as far as it will go.
- Fit the tube end (hose adapter) to the fitting. Then hand tighten the fitting nut.
- Retighten the fitting nut by turning it 180 degrees with an adjustable wrench or spanner.

\*The plastic fitting nut may be broken if it is tightened too much.

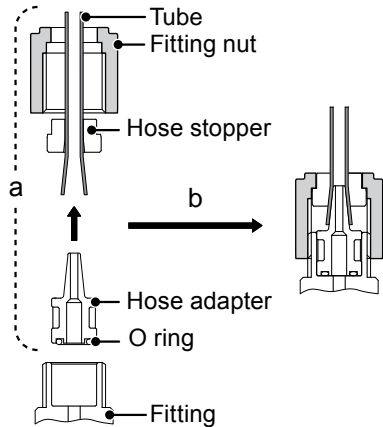

**1** Connect tubes into the inlet and outlet.

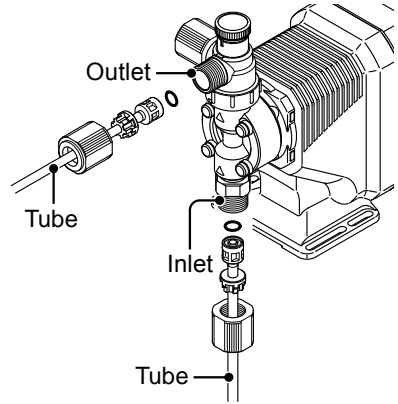

**2** Connect an air bleed tube into the air vent port.

Route back the other tube end to a supply tank or a container.

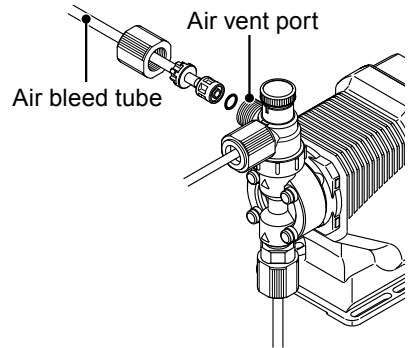

**3** Determine an air vent port direction.

The air vent port can rotate 90 degrees.

- Turn the lock nut anticlockwise.
- Adjust the direction of the air vent port.
- Hand-tighten the lock nut, holding the air vent body A.
- Turn the lock nut 90 degrees clockwise further with an adjustable wrench or spanner.

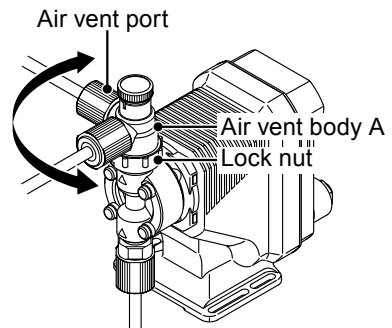

## Check valve mounting

Install an optional check valve to the EJ for the prevention of a back flow, siphon and overfeeding. In the following cases be sure to install the check valve.

- A suction side liquid level is higher than a discharge side or an injection point at atmospheric pressure.

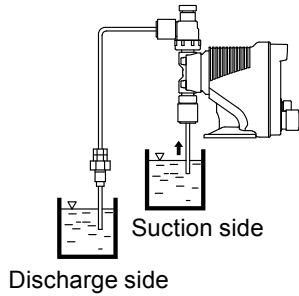

- A discharge side liquid level is higher than a suction side but the distance is 5m or below.

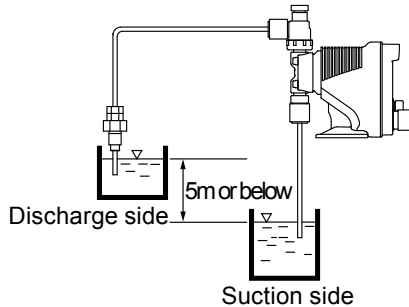

- A suction line pressure is higher than a discharge line pressure.

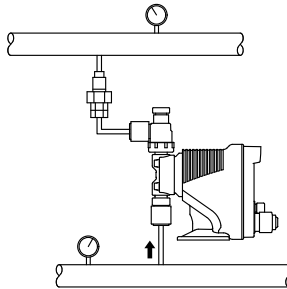

- A discharge pressure (including pipe resistance and discharge head) is below 0.13MPa.

# 1 Mount a check valve at the discharge tube end.

\*The CAN check valve has R1/2 and R3/8 thread connections as well as a  $\varnothing 9$  tube connection. Cut off unnecessary sections before use.

## CAN check valve

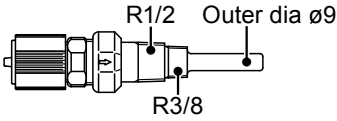

\*The CBN check valve of which the both ends are tube connections is also available. Contact us or your nearest distributor.

## CBN check valve

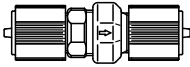

## NOTE

Periodically clean or replace a check valve with new one for the prevention of crystal clogging, especially when using sodium hypochlorite.

## Tubing layout

Flooded suction application

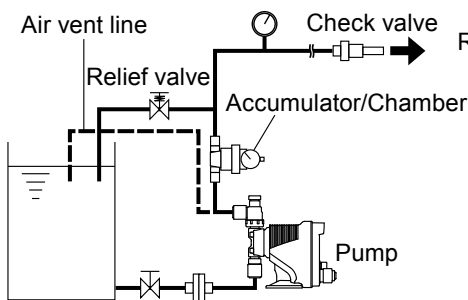

Suction lift application

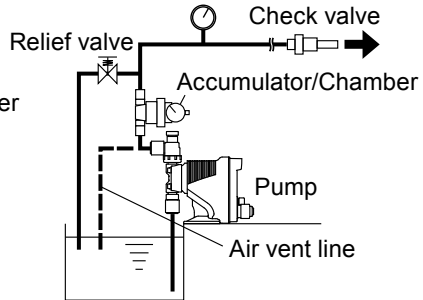

## NOTE

Flooded suction is recommended when handling a gaseous liquid such as sodium hypochlorite.

*Wiring for a power voltage, earthing and an external signal.*

**! Observe the following points during wiring work.**

- Electrical work should be performed by a qualified electrician. Always observe local electric codes.
- Observe the rated voltage range, or the electrical circuit in the control unit may fail.
- Do not perform wiring work while electric power is ON. Otherwise, an electrical shock or a short circuit may result. Be sure to turn off the power before wiring work.
- Be careful for the power not to be turned on during work.
- The power cable is not replaceable.
- The DIN 5-pin male-connector is protected with a protective cap. Do not remove the cap unless the connector is used, or failure may result.
- This pump is supplied with a grounding conductor and ground-type attachment plug. To reduce the risk of electric shock, be certain that it is connected only to a properly grounded, grounding type receptacle.

**Necessary tools**

- Adjustable wrench or spanner
- Phillips screw driver

### ***Power voltage/Earthing***

Check that the main power is turned off.

**1 Plug the pump into the outlet.**

\*Make sure the pump is earthed properly.

## NOTE

- Do not share a power source with a high power device which may generate surge voltage. Otherwise an electronic circuit may fail. The noise caused by an inverter also affects the circuit.
- Energize the pump with a power voltage via a mechanical relay or switch. Do not fluctuate the voltage, or CPU may malfunction. See page 31 for the precautions for ON-OFF control by a mechanical relay.

### Apply power sharply

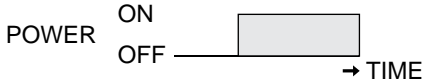

### Do not apply gradually

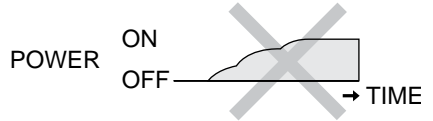

## Surge voltage

The electronic circuit in this pump may fail due to surge voltage. Do not place the pump close to a high power device of 200V or more which may generate large surge voltage. Otherwise, take any of the following measures.

- Install a surge absorption element (ex. a varistor with capacity of 2000A or more) via power cable.

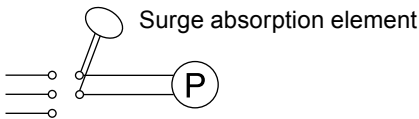

### Recommended varistors

SUNTAN      TSV14D511K

Panasonic    ERZV14D511

See manufacturer's catalogues for detail.

- Install a noise cut transformer via power cable.

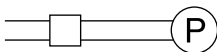

Noise cut transformer

**Precautions for ON-OFF control by a mechanical relay**

This pump is equipped with CPU. Always start/stop the pump by the STOP signal for ON-OFF control. Try not to turn on and off the main power. Otherwise, observe the following points.

- Do not turn ON/OFF power voltage more than six times per hour.
- When using a mechanical relay for ON-OFF operation, its contact capacity should be 5A or more. Contact point may fail if it is less than 5A.
- If a mechanical relay with the contact capacity of 5A is used, the maximum allowable ON/OFF operation is about 150,000 times. The contact capacity should be 10A or more when making ON-OFF operation over 150,000 times or sharing a power source with a large capacity equipment. Otherwise a contact point may fail by surge voltage.
- Use a solid state relay (SSR) as necessary (such as the OMRON G3F). See manufacturer's catalogues for detail.

**Signal wire connection****Points to be checked**

- Check that the main power is turned off.  
The pump is still charged right after turning off power. Wait for one minute before wiring.

**Applicable cables**

Use our optional connector cables below or purchase DIN 5-pin female connector cables when using signal input.

Binder connector cables

5-pin : 713 series 99-0436-10-05    Input signal.

## ■ Input signal

To run the pump in EXT mode or to use STOP function, connect signal wires to the EXT terminal via a DIN 5-pin connector.

- *When using an open collector:*

Pay attention to polarity. PIN 1 and 2 are plus (+), and PIN 3 and 4 are minus (-).

- *When using a contact:*

Use a mechanical relay designed for an electronic circuit. Its minimum application load should be 3mA or less.

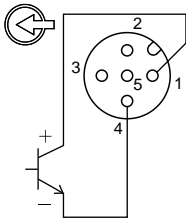

Wiring for  
Pulse signal

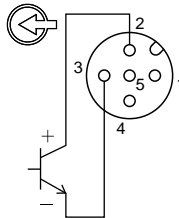

Wiring for  
STOP signal

PIN 1 : Pulse (brown)

PIN 2 : STOP (white)

PIN 3 : COM (blue)

PIN 4 : COM (black)

PIN 5 : N.C. (green)

\*Each terminal is coloured as above for our optional cable.

The PIN 5 is not used.

## NOTE

- Do not lay on these signal cables in parallel with a power cable or combine them in a concentric cable (ex. 5 wires cable). Otherwise noise is generated through the cables due to induction effect and it results in malfunction or failure.
- The following products are the recommended SSRs (Solid State Relays) for signal input. Any other SSRs may cause malfunction. See manufacturer's information for details on these SSRs.
  - OMRON G3FD-102S or G3FD-102SN
  - OMRON G3TA-IDZR02S or G3TA-IDZR02SM
- When using a mechanical relay for signal input, its minimum application load should be 3mA or below.
- Insert the DIN connector as far as it will go and then rotate the outer ring to fix it.
- Our optional cable has 5 wires. Cut off a green wire that is not used.
- PIN 5 is not used. Do not short-circuit it to COM 3 or 4.

\*Use either a no-voltage contact or an open collector.

\*Set pulse duration in 10-100ms and the number of pulses at or below 360 pulses per minute.



# Operation

***This section describes pump operation and programming.  
Run the pump after pipework and wiring is completed.***

## Before operation

*Check a flow rate, tubing and wiring. And then perform degassing and flow rate adjustment before starting operation.*

### ***Points to be checked***

---

*Before operation, check if...*

- Liquid level in a supply tank is enough.
- Tubing is securely connected and is free from leakage and clogging.
- Discharge/suction valves are opened.
- A power voltage is in the allowable range.
- Electrical wiring is correct and is free from the risk of short circuit and electrical leakage.

### ***Retightening of pump head fixing bolts***

---

#### **Important**

The pump head fixing bolts may loosen when plastic parts creep due to temperature change in storage or in transit, and this can lead to leakage. Be sure to retighten the bolts evenly to 19 lb-in in diagonal order before starting operation.

\*Tighten fixing bolts once every three months.

## ■ Use of hexagon wrench instead of a torque wrench

Fasten the fixing bolts as tight as can be by the hand with the straight long part of a hexagon wrench (a) and further turn the bolts clockwise 90 degrees with the short part (b).

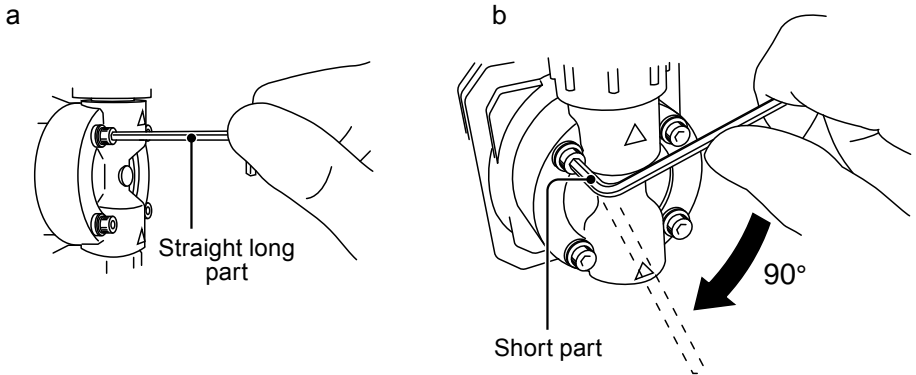

## ***Degassing***

---

*The gas needs to be expelled from the pump and tubing by degassing. Normal performance can not be obtained with gas in the pump. Conduct degassing in the following cases.*

- When the pump starts to run for the first time
- When a flow rate is too low
- After liquid is replaced in a supply tank
- After a long period of stoppage
- After maintenance and inspection

### NOTE

---

- Both gas and chemical come out together through an air bleed tube. Place the end of the tube in a supply tank or a container.
  - Some chemicals may cause skin trouble or damage component parts. When your hand or component parts get wet with chemical liquid, wipe off immediately.
-

## Points to be checked

- An air bleed tube is connected to the pump.

Air bleed tube

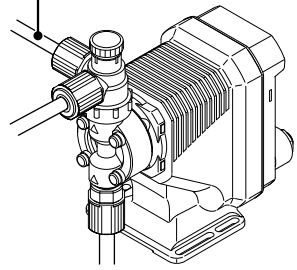

**1**

### Turn on power.

The LED lights and a display related to the current mode appears on the screen.

- \*The pump waits in the MAN mode when the power is turned ON with a default setting or calls up the last selected mode with other settings.

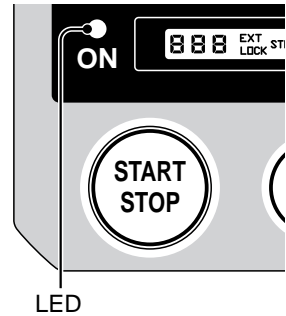

**2**

### Use the UP key to set a stroke rate to 360spm.

- This programming is not necessary when the display already shows 360. Move to the next step.
- If the key is pressed and held, the spm will quickly increases to the max rate.

**3**

### Rotate the adjusting screw two revolutions anticlockwise to open the air vent port.

- \*Do not rotate it three revolutions. Otherwise, liquid may come out from the adjusting screw.

Adjusting screw

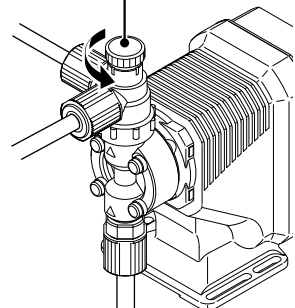

- 4** Push the start/stop key and run the pump for more than ten minutes.

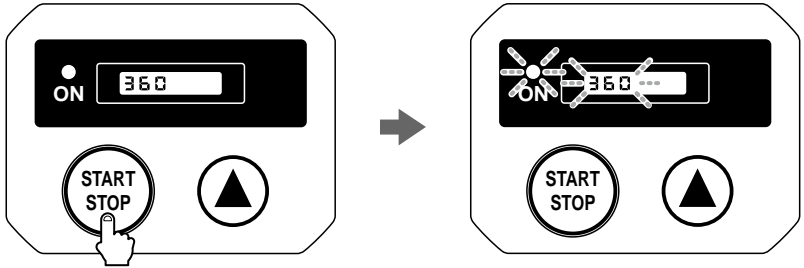

- 5** Push the start/stop key and stop the pump.

- 6** Rotate the adjusting screw clockwise to close the air vent port.

- 7** Check liquid is discharged.

\*Degassing is required again if the pump does not discharge liquid.

- 8** Check connections for leakage.  
Degassing has now been completed.

## Flow rate adjustment

A flow rate can be adjusted only by changing a stroke rate (stroke length adjustment is not available). A stroke rate can be set by keypad operation from 1 to 360spm. The relation between a flow rate\* and a stroke rate is shown as below.

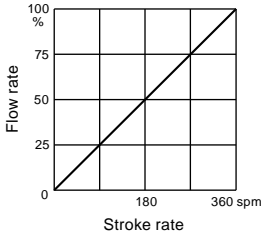

\*The discharge capacity described on the nameplate is the value at 100%.

### 1 Turn on power and call up manual mode.

Enter manual mode to indicate a stroke rate on the screen.

- Push the start/stop key when the pump is in the EXT mode.
- When "STOP" appears on the screen, suspend the STOP signal.

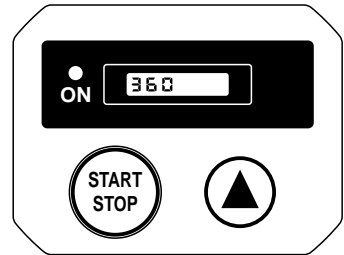

### 2 Determine a stroke rate that will meet a required flow.

See the above table.

### 3 Use the UP key to adjust a stroke rate.

- spm increases as pushing the UP keys.
- Press and hold the key for three seconds for quick increment. Quick increment stops at 360spm. 360spm skips to 1spm when the key is released and pushed once.

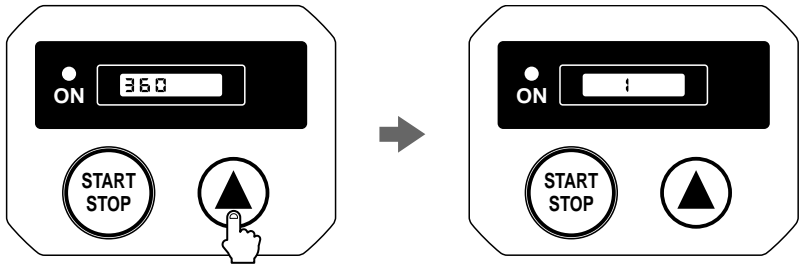

### 4 Measure a flow rate.

### 5 If a flow rate is lower than a specified level, increase a stroke rate.

### 6 Measure the flow again to see the specified level is obtained.

## ***Before a long period of stoppage (one month or more)***

---

### **Clean wet ends and the inside of tubing.**

- Run the pump with clean water for about 30 minutes to rinse chemicals off from the pump head and piping.

### **Before unplugging the pump**

- Always stop the pump by key operation and wait for three seconds before unplugging the pump. Otherwise, the last key operation may not be put in memory. In this case the pump unintentionally starts to run as powered on, discharging liquid.

### **When the pump does not transfer liquid at resuming operation.**

- Clean the valve sets and remove foreign matters.
- If gas is in the pump head, expel gas and readjust a flow rate. See "Degassing" on page 34 and "Flow rate adjustment" on page 37 for detail.

# Operation programming

Operation at each mode is individually set and controlled by keypad operation.  
 Select a proper mode to make optimal operation.

## Programming flow

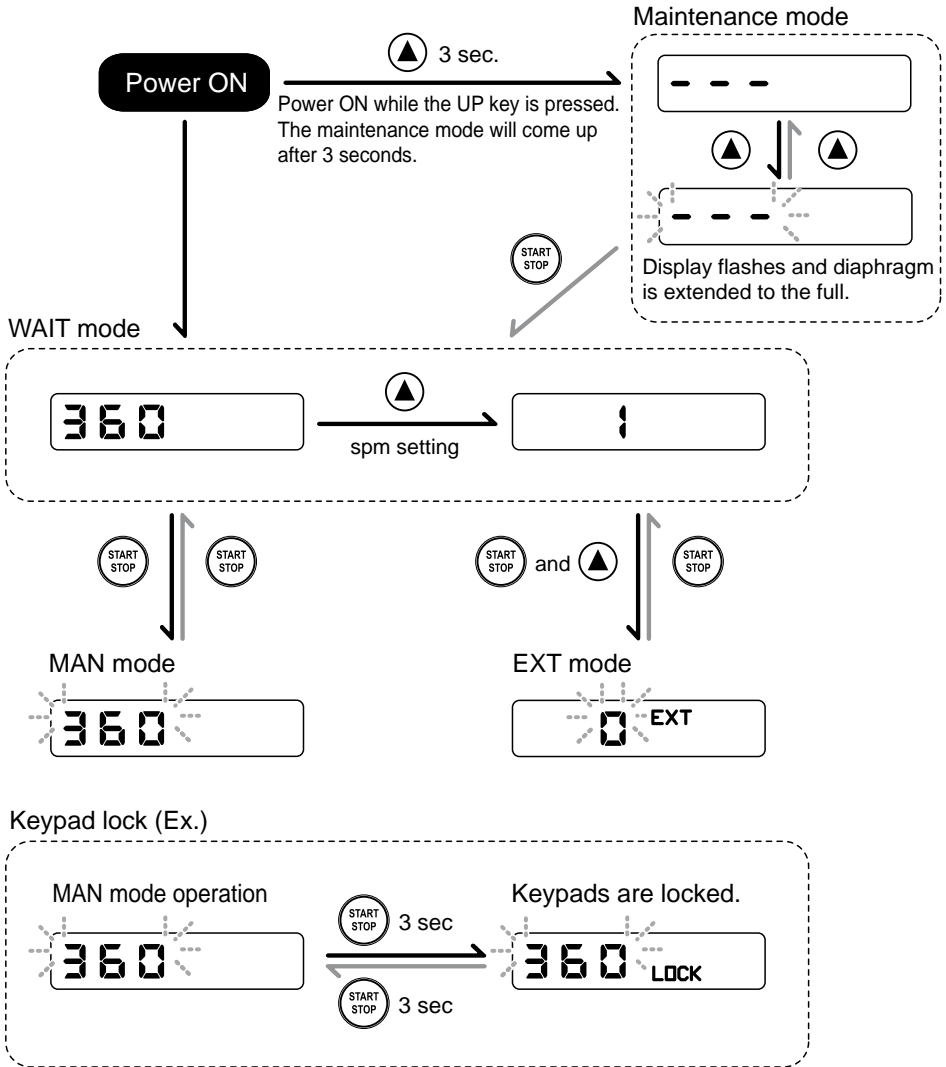

\*The maintenance mode is used for the replacement of a diaphragm.



## 1 Turn on power.

The LED lights and a display related to the current mode appears on the screen.

\*The pump waits in the manual mode when the power is turned ON with a default setting or calls up the last selected mode when powered on with other settings.

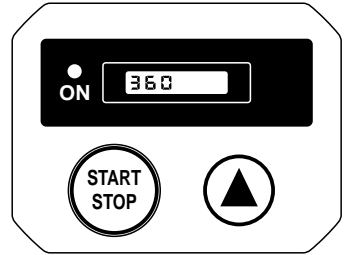

## 2 Enter WAIT mode.

Move to the next step when spm (1-360) is shown on the screen.

**When "EXT" is shown on the screen:**

Push the start/stop key once to return to the WAIT mode.

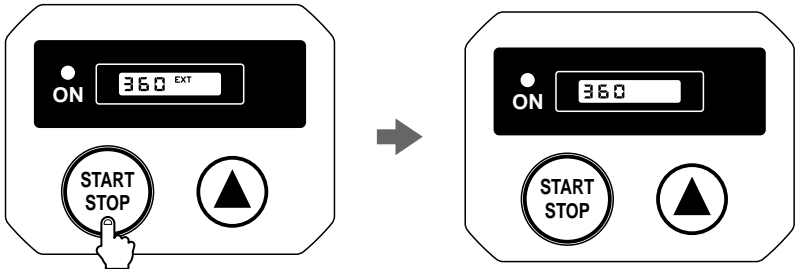

**When "STOP" is shown on the screen:**

Release the STOP signal.

### 3 Use the UP key to set a stroke rate.

- spm increases as pushing the UP key.
- Press and hold the key for three seconds for quick increment. Quick increment stops at 360spm. 360spm skips to 1spm when the key is released and pushed once.

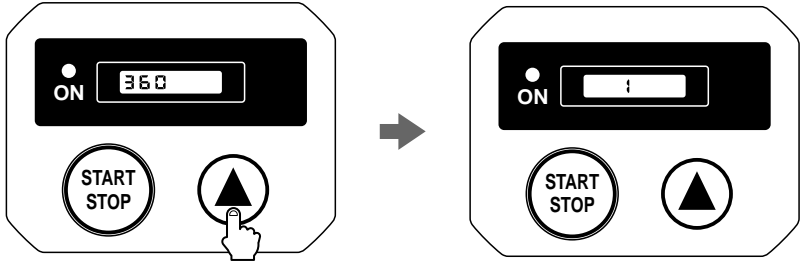

### 4 Push the start/stop key.

The LED and spm indication blink as the pump starts to run.

\*Only the LED blinks in sync with the pump operation.

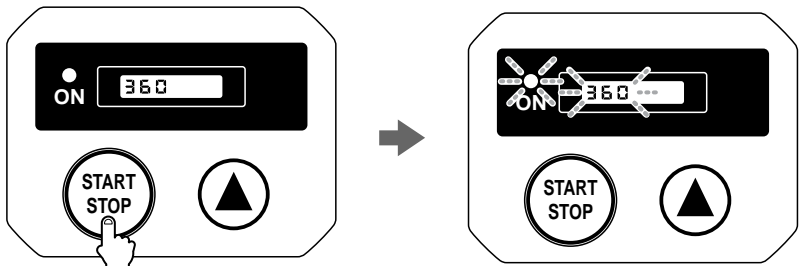

## EXT operation

The pump operation is controlled by the external (pulse) signal. In this mode, the pump runs in sync with each external signal.

### NOTE

The maximum stroke rate is 360spm in the EXT mode.

## 1 Enter WAIT mode.

### When "EXT" is shown on the screen:

The pump is already in the EXT mode and waiting for the input of the external signal.

### When "STOP" is shown on the screen:

Release the STOP signal.

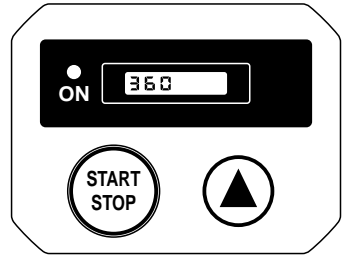

## 2 Push the UP key while pressing the start/stop key.

The mode changes to the EXT mode and starts running as receiving the external signal.

\*The displayed spm shows an actual pump speed in the EXT mode.

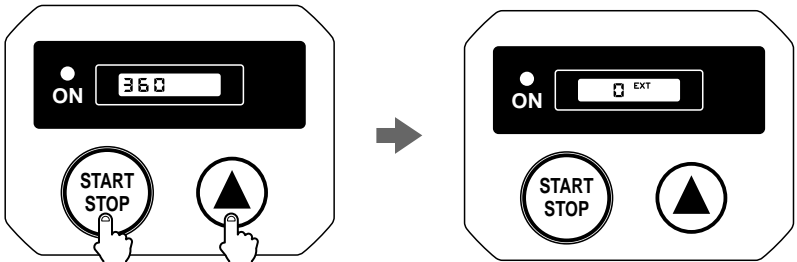

# STOP function

The start/stop of the pump operation can be controlled by the external stop signal. The display changes as below when the STOP signal is inputted.

## MAN mode

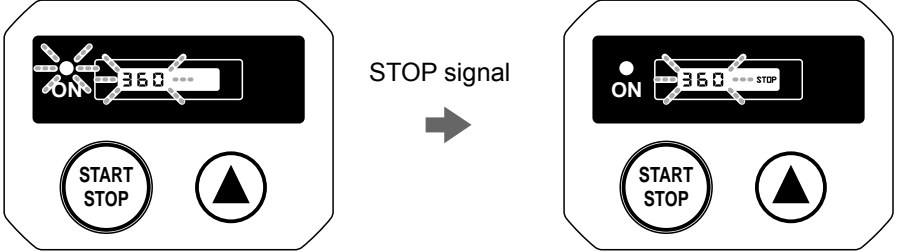

## EXT mode

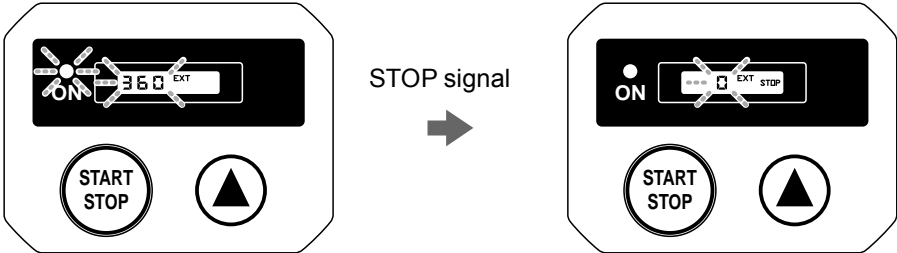

## Keypad lock

Keypad lock can be active in the MAN or EXT mode for the prevention of erroneous key operation. The "LOCK" indication appears while keypads are locked.

### NOTE

Any key operation is not acceptable when the keypads are locked. In an emergency, unplug the pump to stop operation. Plugging in the pump, keypads are locked again.

### ■ Keypad lock activation

- 1 Press and hold the start/stop key for three seconds.

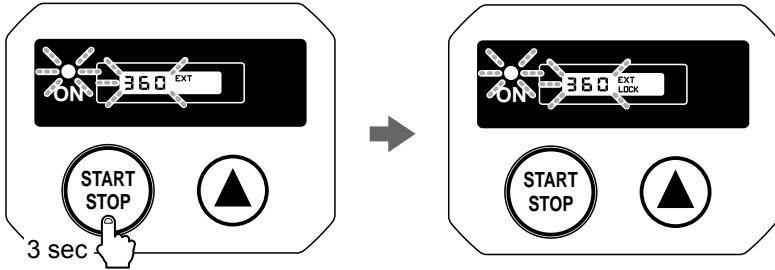

### ■ Keypad lock release

- 1 Press and hold the start/stop key for three seconds.  
Keypad lock is released and key operation becomes acceptable.

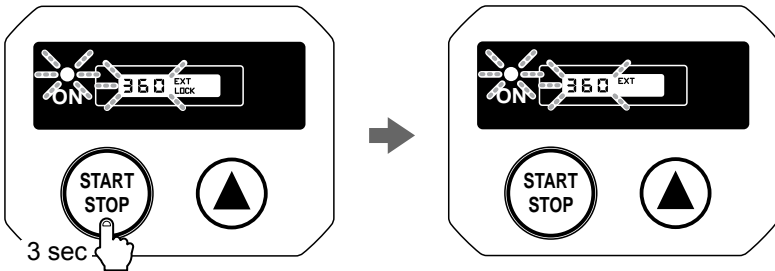

# Maintenance

***This section describes troubleshooting, inspection, wear part replacement, exploded views and specifications.***

## **!** Important

- Follow instructions in this manual for replacement of wear parts. Do not disassemble the pump beyond the extent of the instructions.
- Always wear protective clothing such as an eye protection, chemical resistant gloves, a mask and a face shield during disassembly, assembly or maintenance work. The specific solution will dictate the degree of protection. Refer to MSDS precautions from the solution supplier.
- Risk of electrical shock. Be sure to turn off power to stop the pump and related devices before service is performed.

## **Before unplugging the pump**

Always stop the pump by key operation. And wait for three seconds before unplugging the pump. Otherwise, the last key operation to stop the pump may not be put in memory. In this case the pump unintentionally starts to run as powered on, discharging liquid.

## Troubleshooting

First check the following points. If the following measures do not help removing problems, contact us or your nearest distributor.

States	Possible causes	Solutions
The pump does not run (blank LED or screen).	Power voltage is too low.	<ul style="list-style-type: none"> <li>• Observe the allowable voltage range of 90-264VAC</li> </ul>
	The pump is not powered.	<ul style="list-style-type: none"> <li>• Check the switch if it is installed.</li> <li>• Correct wiring.</li> <li>• Replace a breaking wire to new one.</li> </ul>
	A PCB has failed.	<ul style="list-style-type: none"> <li>• Replace the pump.</li> </ul>
Liquid can not be pumped up.	Air lock in the pump	<ul style="list-style-type: none"> <li>• Expel air. See page 34.</li> </ul>
	Air ingress through a suction line.	<ul style="list-style-type: none"> <li>• Correct tubing.</li> </ul>
	A valve set is installed upside down.	<ul style="list-style-type: none"> <li>• Reinstall the valve set.</li> </ul>
	Valve gaskets are not installed.	<ul style="list-style-type: none"> <li>• Install valve gaskets.</li> </ul>
	Foreign matters are stuck in the pump head valves.	<ul style="list-style-type: none"> <li>• Dismantle, inspect and clean the valves. Replace as necessary.</li> </ul>
	A ball valve is stuck on a valve seat.	<ul style="list-style-type: none"> <li>• Dismantle, inspect and clean the valve. Replace as necessary.</li> </ul>
A flow rate fluctuates.	Air stays in the pump head.	<ul style="list-style-type: none"> <li>• Expel air. See page 34.</li> </ul>
	Overfeeding occurs.	<ul style="list-style-type: none"> <li>• Mount a check valve. See page 27.</li> </ul>
	Foreign matters are stuck in the pump head valves.	<ul style="list-style-type: none"> <li>• Dismantle, inspect and clean the valves. Replace as necessary.</li> </ul>
	Diaphragm is broken.	<ul style="list-style-type: none"> <li>• Replace diaphragm.</li> </ul>
	Pressure fluctuates at an injection point.	<ul style="list-style-type: none"> <li>• Maintain a pressure constant at an injection point by optimizing tubing or by relocating the point.</li> </ul>
Liquid leaks.	The fitting or the air vent body is mounted loose.	<ul style="list-style-type: none"> <li>• Retighten as necessary.</li> </ul>
	The pump head is mounted loose.	<ul style="list-style-type: none"> <li>• Retighten as necessary. See page 33.</li> </ul>
	O rings or valve gaskets are not installed.	<ul style="list-style-type: none"> <li>• Install O rings and valve gaskets.</li> </ul>
	Diaphragm is broken.	<ul style="list-style-type: none"> <li>• Replace the diaphragm.</li> </ul>
	Excessive discharge pressure.	<ul style="list-style-type: none"> <li>• Check that a discharge line is not closed.</li> <li>• Check if tubing is not clogged.</li> </ul>

## Inspection

Perform daily and periodic inspection to keep pump performance and safety.

### **Daily inspection**

---

Check the following points. Upon sensing abnormality, stop operation immediately and remove problems according to "Troubleshooting".

When wear parts come to the life limit, replace them with new ones. Contact us or your nearest distributor for detail.

No.	States	Points to be checked	How to check
1	Pumping	• If liquid is pumped.	Flow meter or visual inspection
		• If the suction and discharge pressure are normal.	Check specifications.
		• If liquid has deteriorated, crystallized or precipitated.	Visual or audio inspection
2	Noise and vibration	• If abnormal noise or vibration occurs. They are signs of abnormal operation.	Visual or audio inspection
3	Air ingress from pump head joints and a suction line	• If leakage occurs. • If pumped liquid includes air bubbles, check lines for leakage and retighten as necessary.	Visual or audio inspection

### **Periodic inspection**

---

Retighten the pump head mounting bolts evenly to the 19 lb-in in diagonal order (once three months).

\*Mounting bolts may loosen in operation. How fast the bolts start to loosen is depending on operating conditions.

\*A hexagon wrench can be used for a torque wrench. See page 34.





## Wear part replacement

To run the pump for a long period, wear parts need to be replaced periodically. It is recommended that the following parts are always stocked for immediate replacement. Contact us or your nearest distributor for detail.

### ! Precautions

- Solution in the discharge line may be under pressure. Release the pressure from the discharge line before disconnecting plumbing or disassembly of the pump to avoid solution spray.
- Rinse wet ends thoroughly with tap water.
- Each time the pump head is dismantled, replace the diaphragm, O rings, and valve sets with new ones.

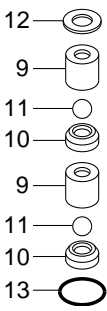
### Wear part list

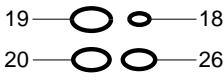
	Parts	# of parts	Estimated life
Pump		2 sets	8000 hours
		1	
		See page 57.	

\*Wear part duration varies with the pressure, temperature and characteristics of liquid.

\*The estimated life is calculated based on the continuous operation with clean water at ambient temperature.

## ***Before replacement***

---

*First release pressure from the pump head.*

**1** Stop the pump operation.

**2** Rotate the adjusting screw two revolutions anticlockwise to open the air vent port.

NOTE

Do not rotate it three revolutions or more. Otherwise, the adjusting screw may come off with solution spray.

---

**3** Check the discharge line and the pump head are depressurized.

Liquid pressure is released from the air vent port in the form of solution spray.

NOTE

If pressurized liquid is not expelled, run the pump with an opened air vent port until pressure is removed.

---

# Valve set replacement

## ■ Discharge valve set disassembly/assembly

### Necessary tools

- Adjustable wrench or spanner
- 0.9 inch (21mm) box wrench
- A pair of tweezers

\*Unfix the pump base before disassembly.

### 1 Loosen the fitting nut to remove a discharge tube and an air bleed tube.

#### NOTE

Wash out residual liquid or substances.

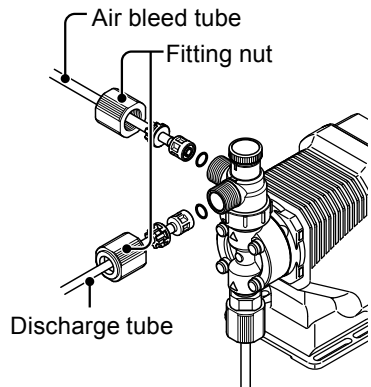

### 2 Turn the lock nut anticlockwise by an adjustable wrench and remove the air vent body A.

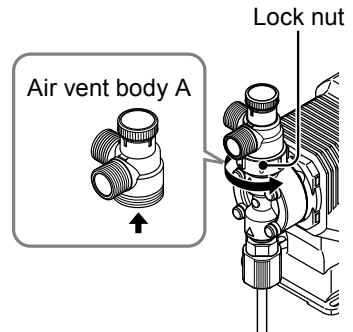

**3** Remove the air vent body B with a 0.9 inch (21mm) box wrench.

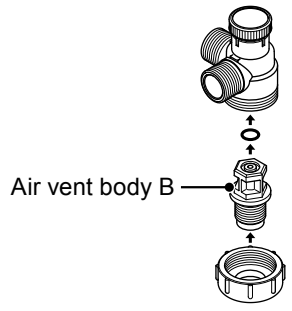

**4** Pull out the valve set by a pair of tweezers.

**5** Place a new valve set into the pump head and screw the air vent body B through the lock nut.

- \*Be careful not to misarrange the valve set or place upside down. Otherwise, leakage or flow rate reduction may result.
- \*Do not forget to fit O rings and gaskets.
- \*Keep the valve set free from dust or foreign matters.

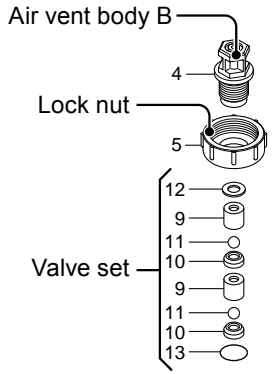

**6** Remount the air vent body A and connect tubes.

## ■ Suction valve set disassembly/assembly

### NOTE

Be careful not to drop the valve set.

### 1 Remove the fitting nut and the suction tube.

#### NOTE

Wash out residual liquid or substances.

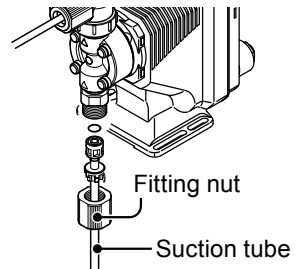

### 2 Remove the fitting by an adjustable wrench or a spanner.

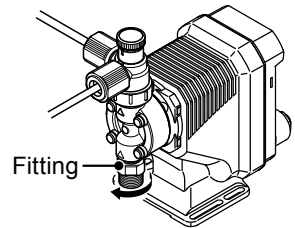

### 3 Pull out the valve set from the fitting by a pair of tweezers.

### 4 Place a new valve set into the fitting. Hand-tighten the fitting into the pump head as far as it will go. Retighten it by a further 1/4 turn with an adjustable wrench or a spanner.

\*Be careful not to misarrange the valve set or place upside down. Otherwise, leakage or flow rate reduction may result.

\*Do not forget to fit O rings and gaskets.

\*Keep the valve set free from dust or foreign matters.

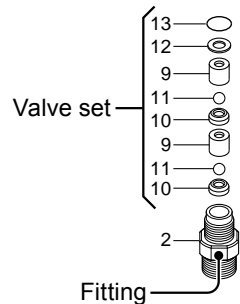

### 5 Reconnect the suction tube.

# Diaphragm replacement

## Necessary tools

- Adjustable wrench or spanner
- Hexagon wrench
- Torque wrench

## NOTE

- Pay attention not to loose diaphragm spacers. Always apply a proper number of diaphragm spacers. 0 or a few diaphragm spacers are inserted between the retainer and plunger for the adjustment of diaphragm location. Note that the number of diaphragm spacers varies with pump model.
- Do not access the pump in or right after operation. Wait until the drive unit of the pump cools down.

**1** Loosen the fitting nuts and remove a suction tube, a discharge tube and an air bleed tube.

**2** Remove the pump head with a hexagon wrench.

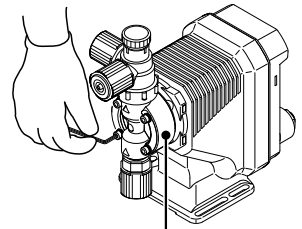

Pump head

**3** Enter the pump into maintenance mode.

Press and hold the UP key and then turn ON the power. Keep the key depressed until the maintenance mode is called up.

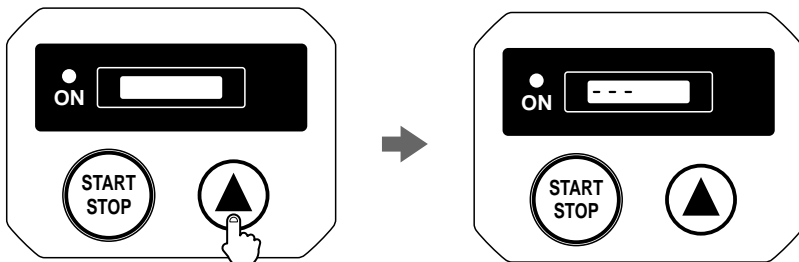

3 sec after powered ON

#### 4 Push the UP key to extend the pump shaft to the full.

\*LCD flashes while the shaft is extended.

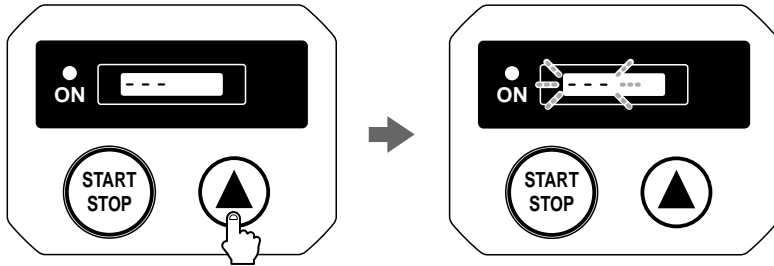

#### NOTE

- Do not extend the shaft any purposes other than the replacement of the diaphragm.
- Do not keep the shaft extended for 10 minutes or more. Push the UP key again to retract the shaft once the time has passed.

#### 5 Rotate and remove the diaphragm from the plunger (pump shaft).

#### 6 Slide a retainer and diaphragm spacer(s) onto the screw of a new diaphragm.

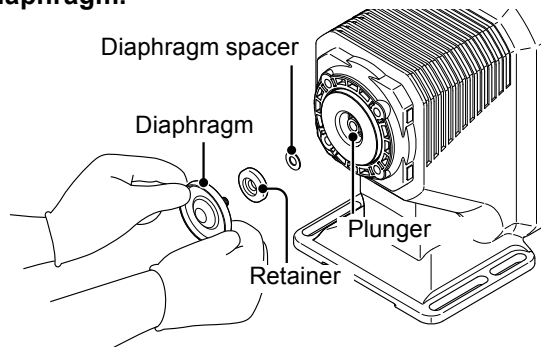

#### 7 Screw the new diaphragm into the plunger as far as it will go.

\*Be careful not to loose the retainer and diaphragm spacer.

**8** Push the UP key again to contract the pump shaft to the minimum.

**9** Push the start/stop key to enter the WAIT mode.

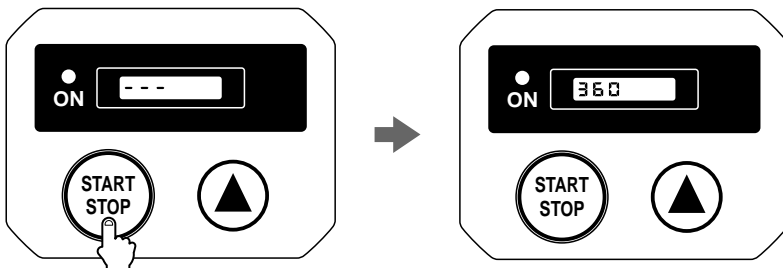

**10** Mount the pump head.

Tighten the pump head fixing bolts evenly to 19 lb-in in diagonal order.

\*A hexagon wrench can be used for a torque wrench. See page 34.



## Exploded view

### ***Pump head & Drive unit***

*The pump in the diagram below is completely dismantled. Do not dismantle the pump beyond the extent shown in this instruction manual.*

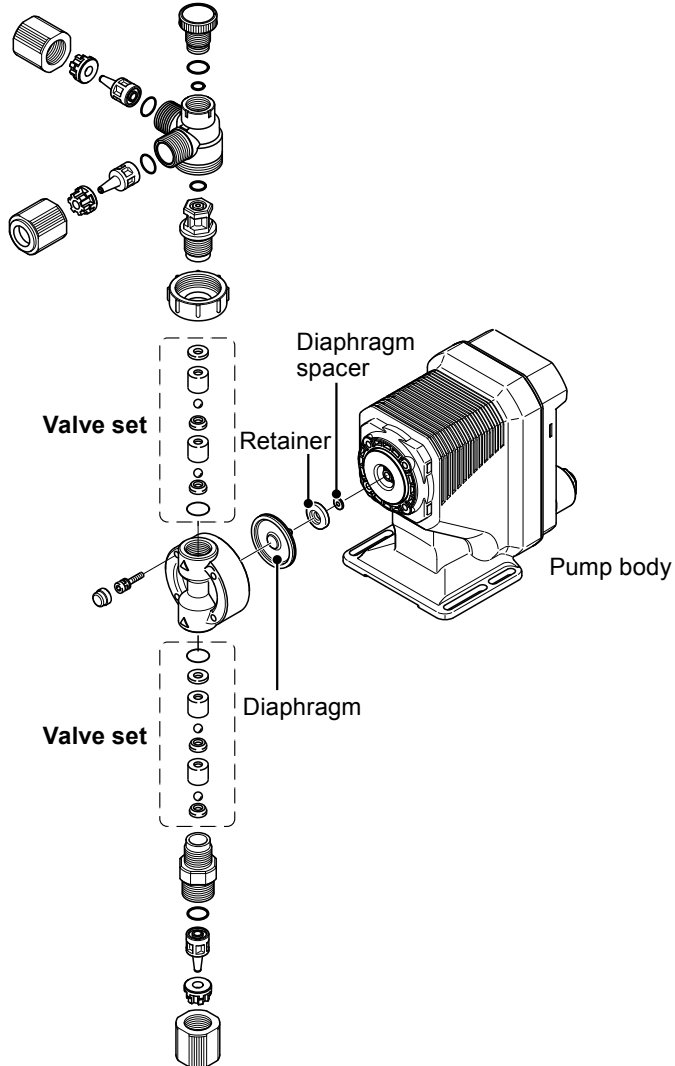

# Pump head

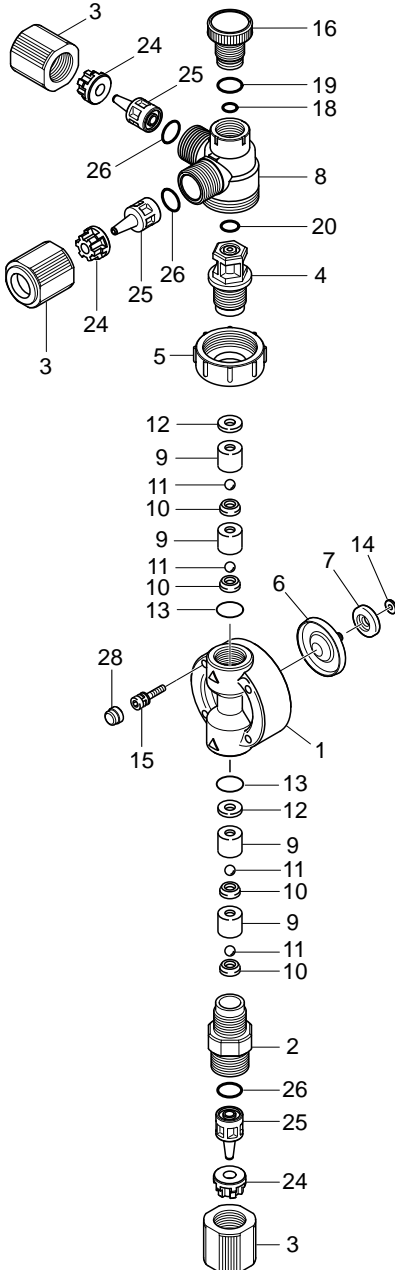

No.	Part names	# of parts
1	Pump head	1
2	Fitting	1
3	Fitting nut	3
4	Air vent body B	1
5	Lock nut	1
6	Diaphragm	1
7	Retainer	1
8	Air vent body A	1
9	Valve guide	4
10	Valve seat	4
11	Valve	4
12	Valve gasket	2
13	O ring	2
14	Diaphragm spacer	*
15	Hex. socket head bolt [PW•SW]	4
16	Adjusting screw	1
18	O ring (P4)	1
19	O ring (P10A)	1
20	O ring (P10)	1
24	Hose stopper	3
25	Hose adaptor	3
26	O ring (P9)	3
28	Bolt cover	4

\*The number of diaphragm spacers varies with pump model.

## Specifications

Information in this section is subject to change without notice.

### ■ Pump unit

Model code	Flow rate GPH (m <sup>3</sup> /min)	Discharge pressure PSI (MPa)	Stroke rate spm	Power con- sumption W	Current value A	Weight lb
EJ-B09	0.30 (19)	174.0 (1.2)	1-360	15	0.8	3.31
EJ-B11	0.48 (30)	145.0 (1.0)				
EJ-B16	0.79 (50)	87.0 (0.6)				
EJ-B21	1.27 (80)	43.5 (0.3)				

\*The above information is based on pumping clean water at rated voltage and ambient temperature.

\*Flow rates were collected at the maximum discharge pressure and 360spm. A flow rate increases as a discharge pressure decreases.

\*Allowable ambient temperature: 0-40°C

\*Allowable liquid temperature: 0-40°C (VC/VE/VH) or 0-60°C (TC)

\*Allowable power voltage deviation: ±10% of the rated voltage

\*Maximum noise level: 65dB at 1m (A scale)

## ■ Control unit

Operation mode	Mode	Manual
		EXT
Stroke rate	Mode selection	Key operation
	Setting range	1-360spm
	Spm programming	UP key
STOP function	Input signal	No-voltage contact or open collector*1
EXT mode	Maximum spm	360 spm
	Pump behaviour	1 shots per signal*2
	Input signal	No-voltage contact or open collector*1
Monitors	LCD	7×3 LCD with three status codes
	LED	Green LED×1 (blinks at each shot)
Buffer		Non-volatile memory
Power voltage*3		U: 100-120VAC 50/60Hz U2: 100-240VAC 50/60Hz

\*1 The maximum applied voltage from the EJ to an external contact is 15V at 3mA. When using a mechanical relay, the minimum application load should be 3mA or below.

\*2 When the external pulse signal is entered to run the pump over the max spm, the signal is cancelled.

\*3 Observe the allowable voltage range (U: 90-132VAC, U2: 90-264VAC). Otherwise failure may result.

## ■ Power cable

Conduction section area	0.824 mm <sup>2</sup> (18AWG)
Length	78.74" (inch)
Standard	SJTW
Terminal treatment	American plug

## ■ Pump colour

Blue	Munsell colour system 7.5PB 3/8
Red	Munsell colour system 5R 3/10

# Outer dimensions

## ■ EJ-B09/-B11/-B16/-B21 VC/VE/VH

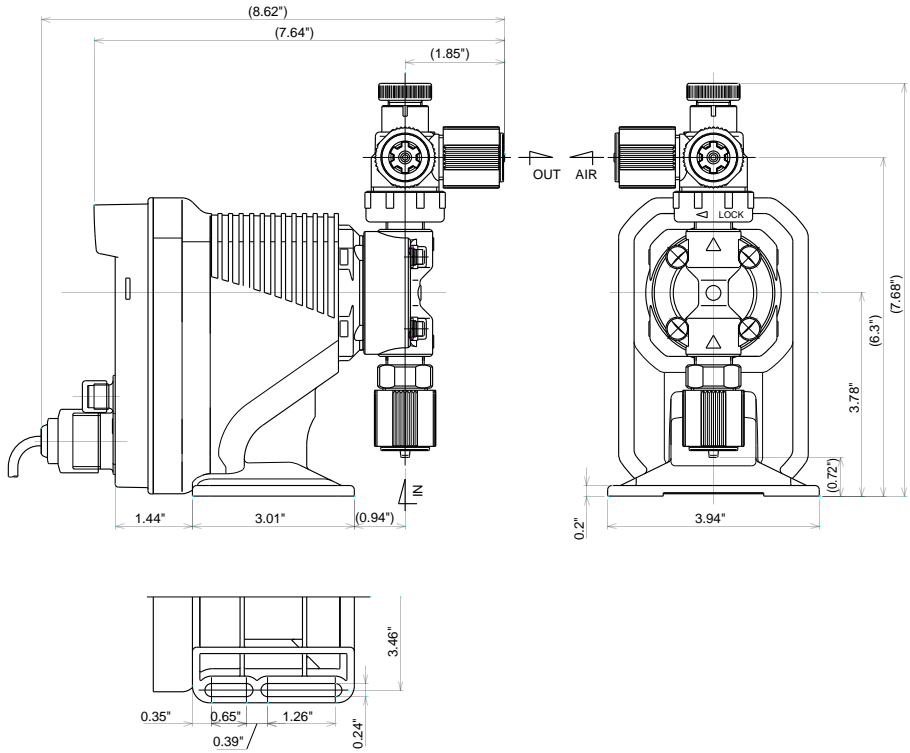

■ EJ-B11/-B16/-B21 TC

